



# HIT<sup>®</sup> Power 210A

**Module Efficiency: 16.7%**  
**Cell Efficiency: 18.9%**  
**Power Output - 210 Watts**



**HIT<sup>®</sup> Power**  
Photovoltaic Module

## High Efficiency

HIT<sup>®</sup> Power solar panels are leaders in sunlight conversion efficiency. Obtain maximum power within a fixed amount of space. Save money using fewer system attachments and racking materials, and reduce costs by spending less time installing per watt. HIT Power models are ideal for grid-connected solar systems, areas with performance based incentives, and renewable energy credits.

## Power Guarantee

SANYO's power ratings for HIT Power panels guarantee customers receive 100% of the nameplate rated power (or more) at the time of purchase, enabling owners to generate more kWh per rated watt, quicken investments returns, and help realize complete customer satisfaction.

## Temperature Performance

As temperatures rise, HIT Power solar panels produce 10% or more electricity (kWh) than conventional crystalline silicon solar panels at the same temperature.

## Valuable Features

The packing density of the panels reduces transportation, fuel, and storage costs per installed watt.

## American Made Quality

SANYO silicon wafers located inside HIT solar panels are made in California and Oregon, and the panels are assembled in an ISO 9001 (quality), 14001 (environment), and 18001 (safety) certified factory. Unique eco-packing minimizes cardboard waste at the job site. The panels have a Limited 20-Year Power Output and 5-Year Product Workmanship Warranty.

## SANYO HIT<sup>®</sup> Solar Cell Structure

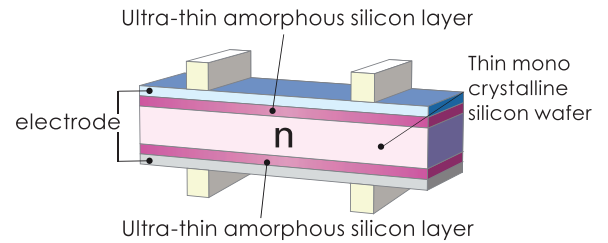

## SANYO'S Proprietary Technology

HIT solar cells are hybrids of mono crystalline silicon surrounded by ultra-thin amorphous silicon layers, and are available solely from SANYO.

## Unnecessary Section When Using SANYO

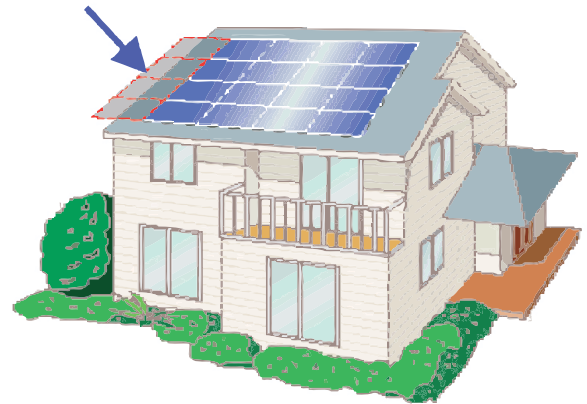

## Increased Performance with SANYO

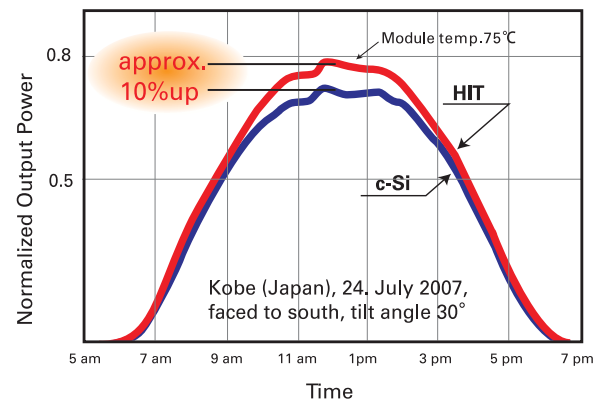

# HIT Power 210A

## Electrical Specifications

Model	HIT Power 210A or HIT-N210A01
Rated Power (Pmax) <sup>1</sup>	210 W
Maximum Power Voltage (Vpm)	41.3 V
Maximum Power Current (Ipm)	5.09 A
Open Circuit Voltage (Voc)	50.9 V
Short Circuit Current (Isc)	5.57 A
Temperature Coefficient (Pmax)	-0.336%/ °C
Temperature Coefficient (Voc)	-0.142 V/ °C
Temperature Coefficient (Isc)	1.95 mA/ °C
NOCT	114.8°F (46°C)
CEC PTC Rating	194.9 W
Cell Efficiency	18.9%
Module Efficiency	16.7%
Watts per Ft. <sup>2</sup>	15.48 W
Maximum System Voltage	600 V
Series Fuse Rating	15 A
Warranted Tolerance (-/+)	-0% / +10%

## Mechanical Specifications

Internal Bypass Diodes	3 Bypass Diodes
Module Area	13.56 Ft <sup>2</sup> (1.26m <sup>2</sup> )
Weight	35.3 Lbs. (16kg)
Dimensions LxWxH	62.2x31.4x1.8 in. (1580x798x46 mm)
Cable Length +Male/-Female	46.45/40.55in. (1180/1030 mm)
Cable Size / Type	No. 12 AWG / PV Cable
Connector Type <sup>3</sup>	Multi-Contact <sup>®</sup> Type IV (MC4 <sup>™</sup> )
Static Wind / Snow Load	60PSF (2880Pa) / 39PSF (1867Pa)
Pallet Dimensions LxWxH	63.2x32x72.8 in. (1607x815x1850 mm)
Quantity per Pallet / Pallet Weight	34 pcs./1234.5 Lbs (560 kg)
Quantity per 53' Trailer	952 pcs.

## Operating Conditions & Safety Ratings

Ambient Operating Temperature <sup>2</sup>	-4°F to 115°F (-20°C to 46°C)
Hail Safety Impact Velocity	1" hailstone (25mm) at 52 mph (23m/s)
Fire Safety Classification	Class C
Safety & Rating Certifications	UL 1703, cUL, CEC
Limited Warranty	5 Years Workmanship, 20 Years Power Output

<sup>1</sup> STC: Cell temp. 25°C, AM1.5, 1000W/m<sup>2</sup> <sup>2</sup> Monthly average low and high of the installation site.  
 Note: Specifications and information above may change without notice.  
 All modules connected in the solar array should be of the same model number.  
<sup>3</sup> Safety locking clip (PV-SSH4) is not supplied with the module.

## Dimensions

Unit: inches (mm)

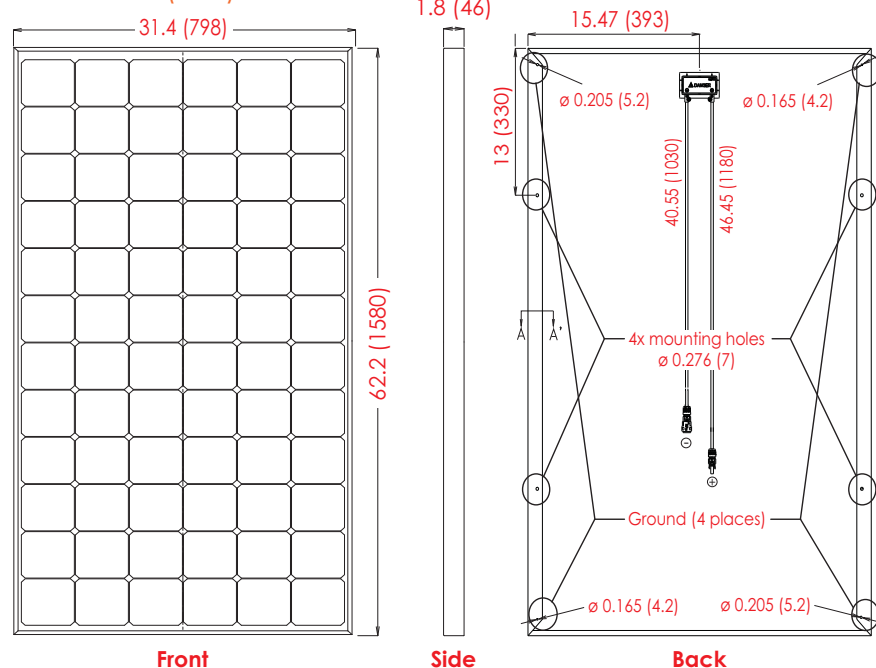

## Dependence on Temperature

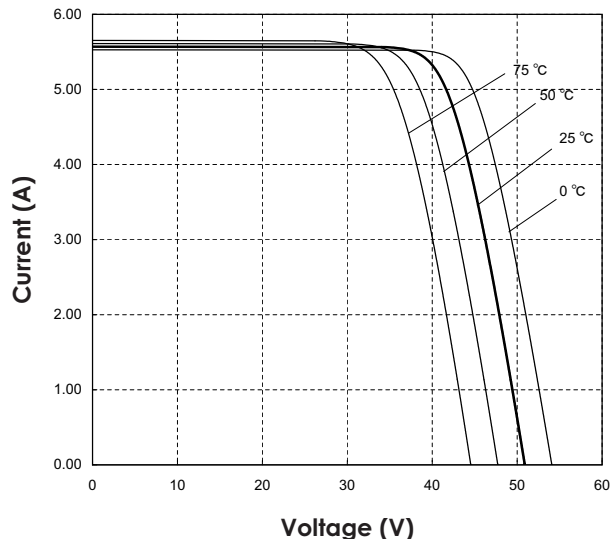

## Dependence on Irradiance

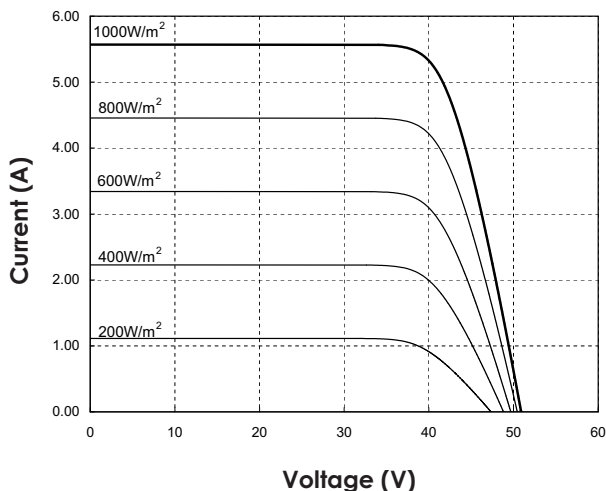

### Section A-A'

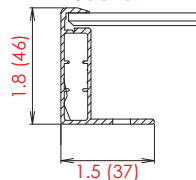

HIT<sup>®</sup> is a registered trademark of SANYO Electric Co.,Ltd.. The name "HIT<sup>®</sup>" comes from "Heterojunction with intrinsic Thin-layer" which is an original technology of SANYO Electric Co.,Ltd..



**CAUTION!**

Read the operating instructions carefully before use of these products

# SANYO

SANYO North America  
Energy System Solutions Division

550 S. Winchester Blvd., Suite 510  
San Jose, CA 95128, U.S.A.  
www.sanyo.com/solar  
solar@sec.sanyo.com