

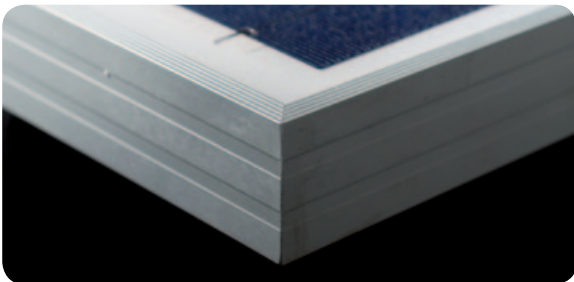

Power Your Life

YL 280 P-35b / 1970x990 SERIES

YL 260 P-35b . YL 265 P-35b . YL 270 P-35b
YL 275 P-35b . YL 280 P-35b



ABOUT YINGLI SOLAR

Yingli Solar is a vertically integrated manufacturer of solar photovoltaic modules. Under one roof we manufacture our ingots, wafers, cells and modules. This ensures that we can tightly control our material and production quality, offering our customers leading product durability and sustainable performance backed by our 25 year limited power warranty*.

PERFORMANCE

- >> High efficiency, polycrystalline solar cells with high transmission and textured glass delivering a module series efficiency of up to 14.4%, minimising installation costs and maximising the kWh output of your system per unit area.
- >> Power tolerance of +/-3% minimising PV system mismatch losses.

QUALITY & RELIABILITY

- >> Robust, corrosion resistant aluminium frame independently tested to withstand wind loads of 2.4KPa and snow loads of 5.4KPa ensuring a stable mechanical life for your modules.
- >> Take confidence in our modules with a 5 year limited product warranty and a 25 year limited power warranty*.
- >> Modules protected by box during transportation and with 21 modules in a box on-site waste is minimised.
- >> Modules independently tested to ensure conformance with certification and regulatory standards.
- >> Manufacturing facility certified to ISO 9001 Quality Management System standards.

WARRANTIES

5-year limited product warranty*
Limited power warranty*: 10 years at 90% of the minimal rated power output, 25 years at 80% of the minimal rated power output

QUALIFICATIONS AND CERTIFICATES

IEC 61215 Edition 2, IEC 61730 Class A, CE, ISO 9001



- Qualified, IEC 61215
- Safety tested, IEC 61730
- Periodic Inspection



* In compliance with our Warranty Terms and Conditions

YL 280 P-35b / 1970x990 SERIES

ELECTRICAL PARAMETERS

Electrical parameters at STC (1,000 W/m², 25°C, AM 1.5 according to EN 60904-3)

Module type	YL 260 P-35b	YL 265 P-35b	YL 270 P-35b	YL 275 P-35b	YL 280 P-35b	
Power output	[W]	260.0	265.0	270.0	275.0	280.0
Power output tolerances	[%]	+/- 3	+/- 3	+/- 3	+/- 3	+/- 3
Module Efficiency	[%]	13.3	13.6	13.8	14.1	14.4
Voltage at Pmax, V _{mpp}	[V]	35.0	35.3	35.3	35.5	35.5
Current at Pmax, I _{mpp}	[A]	7.43	7.50	7.65	7.75	7.89
Open circuit voltage V _{oc}	[V]	44.6	44.6	44.8	45.0	45.0
Short circuit current I _{sc}	[A]	8.04	8.15	8.20	8.30	8.35
Max. system Voltage	[V]	1,000 VDC				

Parameters of the thermal characteristics

NOCT (Nominal Operating Cell Temperature)	[°C]	46 +/- 2
Temperature coefficient beta of I _{sc}	[1/K]	+ 0.0006
Temperature coefficient alpha of V _{oc}	[1/K]	- 0.0037
Temperature coefficient gamma of P _{mpp}	[1/K]	- 0.0045

MECHANICAL PARAMETERS

Dimensions (length [mm] / width [mm] / thickness [mm])	1,970 / 990 / 50
Thickness with junction box [mm]	50
Weight [kg]	26.0
Junction box (manufacturer / protection degree / number of diodes)	CIXI / IP65 / 6
Junction box dimensions (length / width / thickness [mm])	151 / 122 / 25
Positive cable & negative cable (manufacturer / length [mm] / cable cross-section [mm ²])	CIXI / 1,200 / 4.0
Plug connector (manufacturer / type / protection degree)	MC4 / UV resistance and self-locking / IP67
Front cover (material / thickness [mm])	Tempered Glass, 4.0mm
Cell type (quantity / technology)	72 / polycrystalline / 156 x 156
Encapsulation materials	Ethylene Vinyl Acetate (EVA)
Rear cover (material / thickness [mm])	Le - PET - PVDF / 0.287
Frame (material)	robust anodized aluminum alloy

OPERATING CONDITIONS

Operating temperature [°C]	- 40 to + 85
Max. wind load / Max. snow load [Pa]	2.4K / 5.4K

PACKAGING

Number of modules per box	21
Box size (length [mm] / width [mm] / depth [mm])	1,995 / 1,130 / 1,131
Box Gross weight in kg	586
Boxes per pallet	1

* The data does not refer to a single module and they are not part of the offer, they serve for comparison only to different module types.

Yingli Green Energy Holding Co. Ltd.
commerce@yinglisolar.com
0086 - (0)312 - 8929802

Subject to modifications and errors

IV CURVES

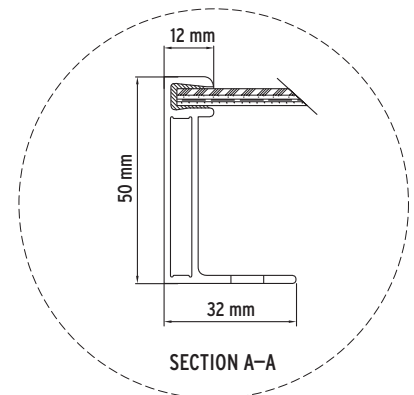
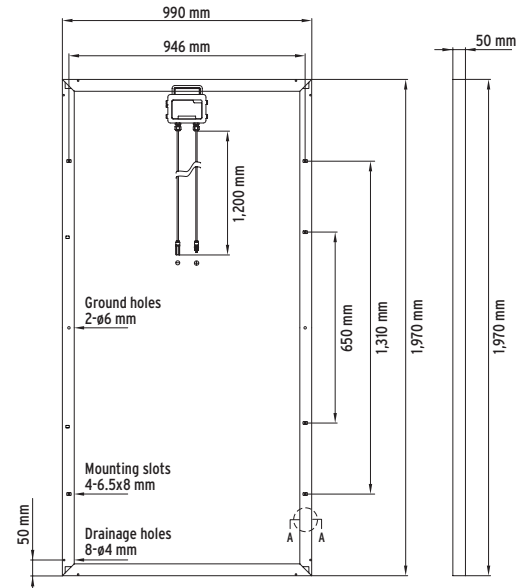
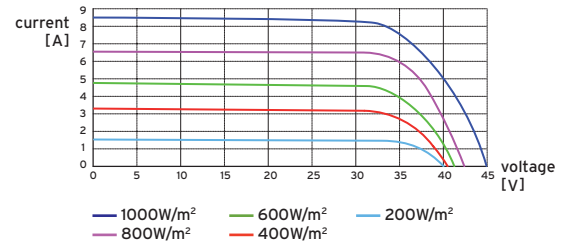

Electrical equipment, check with your installer

